

Temposonics®

Magnetostrictive Linear Position Sensors

R-Series V RP5 POWERLINK Data Sheet

- Minimum position resolution 0.5 μm
- Position and velocity measurements for up to 30 magnets
- Field adjustments and diagnostics using the new TempoLink smart assistant



I AM THE NEW GENERATION

MEASURING TECHNOLOGY

The absolute, linear position sensors provided by MTS Sensors rely on the company's proprietary Temposonics® magnetostrictive technology, which can determine positions with a high level of precision and robustness.

Each Temposonics® position sensor consists of a ferromagnetic waveguide, a position magnet, a strain pulse converter and supporting electronics. The magnet, connected to the object in motion in the application, generates a magnetic field at its location on the waveguide. A short current pulse is applied to the waveguide. This creates a momentary radial magnetic field and torsional strain on the waveguide. The momentary interaction of the magnetic fields releases a torsional strain pulse that propagates the length of the waveguide. When the ultrasonic wave reaches the end of the waveguide it is converted into an electrical signal. Since the speed of the ultrasonic wave in the waveguide is precisely known, the time required to receive the return signal can be converted into a linear position measurement with both high accuracy and repeatability.

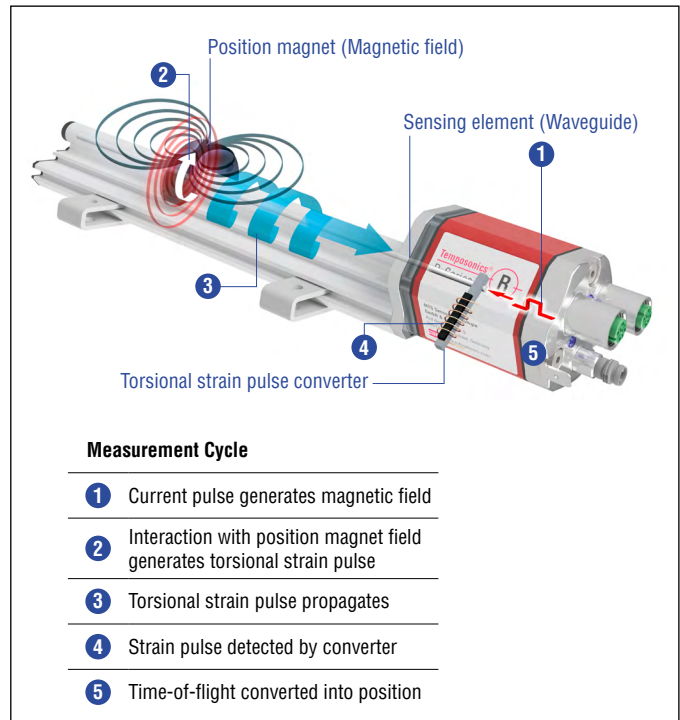

Fig. 1: Time-of-flight based magnetostrictive position sensing principle

R-SERIES V POWERLINK

Temposonics® R-Series V brings very powerful sensor performance to meet the many demands of your application. The R-Series V is the long term solution for harsh environments that have high levels of shock and vibration. The sensor is equipped with POWERLINK V2 and supports a minimum cycle time of 250 μ s. In time-critical applications, the linear extrapolation can be activated. This offers a cycle time of 200 μ s for every sensor stroke length. The measurement of the sensor can be synchronized to the polling cycle of the controller. Temposonics® R-Series V sensors are available with internal linearization which offers improved linearity for overall higher accuracy of the position measurement values. In addition to the measured position value via the POWERLINK protocol further data about the current sensor status, such like the total distance travelled, the internal temperature and the total operating hours, can be displayed for diagnostic purposes.

With many outstanding features the R-Series V sensors are fit for a very broad range of applications.

TempoLink SMART ASSISTANT

The TempoLink smart assistant is an accessory for the R-Series V family of sensors that supports setup and diagnostics. Depending on the sensor protocol it enables the adjustment of parameters like measurement direction, resolution and filter settings. For diagnostics and analysis of operational data the R-Series V sensors continuously track values such as total distance traveled by the position magnet, internal temperature of the sensor and the quality of the position signal. This additional information can be read out via TempoLink smart assistant even while the sensor remains operational in the application. TempoLink smart assistant is connected to the sensor via the power connection, which now adds bidirectional communication for setup and diagnostics. The TempoLink smart assistant is operated using a graphical user-interface that will be displayed on your smartphone, tablet, laptop or PC. Just connect your Wi-Fi-enabled device to TempoLink Wi-Fi access point and go to the website URL for the user-interface.



Fig. 2: R-Series V sensor with TempoLink smart assistant

TECHNICAL DATA

Output						
Interface	Ethernet POWERLINK					
Data protocol	POWERLINK V2					
Measured value	Position, velocity/option: Simultaneous multi-position and multi-velocity measurements up to 30 magnets					
Measurement parameters						
Resolution: Position	0.5...100 µm (selectable)					
Cycle time	Stroke length	≤ 50 mm	≤ 715 mm	≤ 2000 mm	≤ 4675 mm	≤ 6350 mm
	Cycle time	250 µs ¹	500 µs	1000 µs	2000 µs	2800 µs
Linearity deviation ²	Stroke length	≤ 500 mm	> 500 mm			
	Linearity deviation	≤ ±50 µm	< 0.01 % F.S.			
	Optional internal linearity: Linearity tolerance (applies for the first magnet for multi-position measurement)					
	Stroke length	25...300 mm	300...600 mm	600...1200 mm	1200...3000 mm	3000...5000 mm 5000...6350 mm
	typical	± 15 µm	± 20 µm	± 25 µm	± 45 µm	± 85 µm ± 95 µm
	maximum	± 25 µm	± 30 µm	± 50 µm	± 90 µm	± 150 µm ± 190 µm
Repeatability	< ±0.001 % F.S. (minimum ±2.5 µm) typical					
Hysteresis	< 4 µm typical					
Temperature coefficient	< 15 ppm/K typical					
Operating conditions						
Operating temperature	-40...+85 °C (-40...+185 °F)					
Humidity	90 % relative humidity, no condensation					
Ingress protection	IP67 (connectors correctly fitted)					
Shock test	150 g/11 ms, IEC standard 60068-2-27					
Vibration test	30 g/10...2000 Hz, IEC standard 60068-2-6 (excluding resonant frequencies)					
EMC test	Electromagnetic emission according to EN 61000-6-3					
	Electromagnetic immunity according to EN 61000-6-2					
	The sensor meets the requirements of the EC directives and is marked with CE					
Magnet movement velocity	Magnet slider: Max. 10 m/s; U-magnet: Any; block magnet: Any					
Design / Material						
Sensor electronics housing	Aluminum (painted), zinc die cast					
Sensor profile	Aluminum					
Stroke length	25...6350 mm (1...250 in.)					
Mechanical mounting						
Mounting position	Any					
Mounting instruction	Please consult the technical drawings on page 4					
Electrical connection						
Connection type	2 × M12 female connectors (5 pin), 1 × M8 male connector (4 pin)					
Operating voltage	+12...30 VDC ±20 % (9.6...36 VDC)					
Power consumption	Less than 4 W typical					
Dielectric strength	500 VDC (DC ground to machine ground)					
Polarity protection	Up to -36 VDC					
Overvoltage protection	Up to 36 VDC					

1/ Minimum cycle time for multi-position measurements (number of magnets ≥ 2): 400 µs

2/ With position magnet # 252 182

TECHNICAL DRAWING

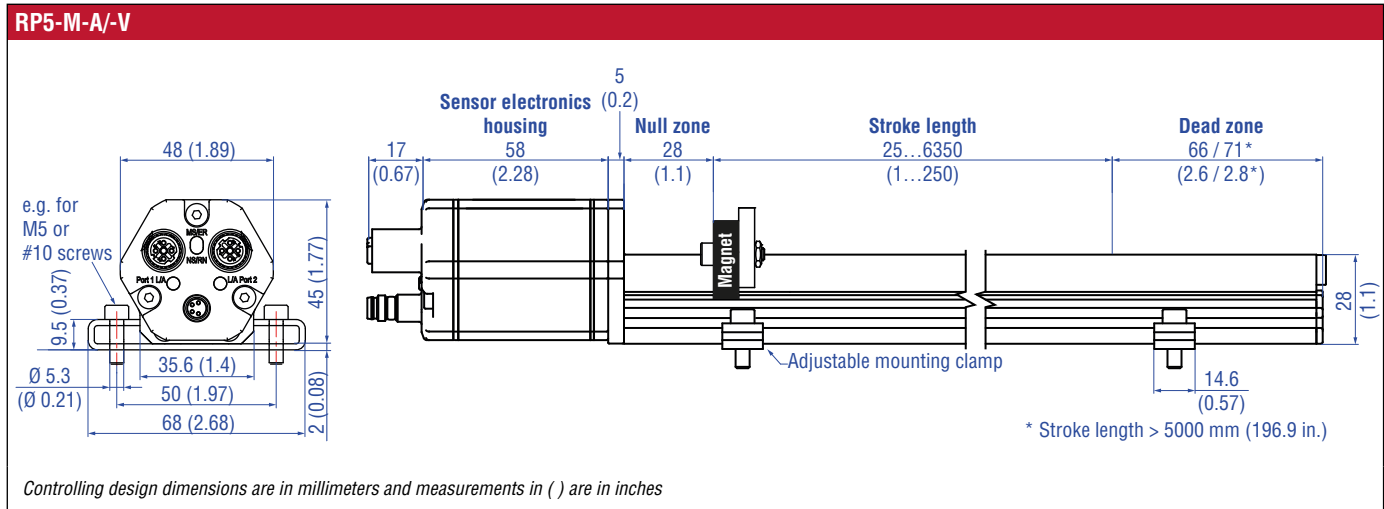

Fig. 3: Temposonics® RP5 with U-magnet

CONNECTOR WIRING

D56		
Signal		
Port 1 – M12 female connector (D-coded)	Pin	Function
<p>View on sensor</p>	1	Tx (+)
	2	Rx (+)
	3	Tx (-)
	4	Rx (-)
	5	Not connected
Port 2 – M12 female connector (D-coded)	Pin	Function
<p>View on sensor</p>	1	Tx (+)
	2	Rx (+)
	3	Tx (-)
	4	Rx (-)
	5	Not connected
Power supply		
M8 male connector	Pin	Function
<p>View on sensor</p>	1	+12...30 VDC (±20 %)
	2	Not connected
	3	DC Ground (0 V)
	4	Not connected

Fig. 4: Connector wiring D56

FREQUENTLY ORDERED ACCESSORIES – Additional options available in our [Accessories Guide](#) 551444



Position magnets			
<p>Magnet slider S, joint at top Part no. 252 182</p> <p>Material: GRP, magnet hard ferrite Weight: Approx. 35 g Operating temperature: -40...+85 °C (-40...+185 °F)</p>	<p>Magnet slider V, joint at front Part no. 252 184</p> <p>Material: GRP, magnet hard ferrite Weight: Approx. 35 g Operating temperature: -40...+85 °C (-40...+185 °F)</p>	<p>Magnet slider N longer ball-joint arm Part no. 252 183</p> <p>Material: GRP, magnet hard ferrite Weight: Approx. 35 g Operating temperature: -40...+85 °C (-40...+185 °F)</p>	<p>Magnet slider G, backlash free Part no. 253 421</p> <p>Material: GRP, magnet hard ferrite Weight: Approx. 25 g Operating temperature: -40...+85 °C (-40...+185 °F)</p>



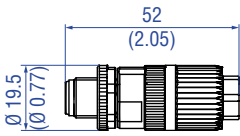
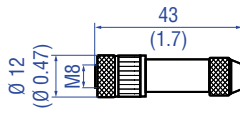

Position magnets	Mounting accessories		
<p>U-magnet OD33 Part no. 251 416-2</p> <p>Material: PA ferrite GF20 Weight: Approx. 11 g Surface pressure: Max. 40 N/mm² Fastening torque for M4 screws: 1 Nm Operating temperature: -40...+105 °C (-40...+221 °F)</p> <p>Marked version for sensors with internal linearization: Part no. 254 226</p>	<p>Block magnet L Part no. 403 448</p> <p>Material: Plastic carrier with hard ferrite magnet Weight: Approx. 20 g Fastening torque for M4 screws: 1 Nm Operating temperature: -40...+75 °C (-40...+167 °F) This magnet may influence the sensor performance specifications for some applications.</p>	<p>Mounting clamp Part no. 400 802</p> <p>Material: Stainless steel (AISI 304)</p>	<p>T-nut Part no. 401 602</p> <p>Fastening torque for M5 screw: 4.5 Nm</p>

Controlling design dimensions are in millimeters and measurements in () are in inches

Temposonics® R-Series V RP5 POWERLINK

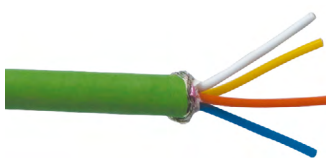
Data Sheet

Cable connectors*	Programming kit	Cables	
 <p>M12 D-coded male connector (4 pin), straight Part no. 370 523</p>	 <p>M8 female connector (4 pin), straight Part no. 370 504</p>	 <p>TempoLink kit for Temposonics® R-Series V Part no. TL-1-0-EM08 (for D56)</p>	 <p>Cable with M8 female connector (4 pin), straight – pigtail Part no. 530 066 (5 m (16.4 ft.)) Part no. 530 096 (10 m (32.8 ft.)) Part no. 530 093 (15 m (49.2 ft.))</p>
<p>Material: Zinc nickel-plated Termination: Insulation-displacement Cable Ø: 5.5...7.2 mm (0.2...0.28 in.) Wire: 24 AWG – 22 AWG Operating temperature: –25...+85 °C (–13...+185 °F) Ingress protection: IP65 / IP67 (correctly fitted) Fastening torque: 0.6 Nm</p>	<p>Material: CuZn nickel plated Termination: Solder Cable Ø: 3.5...5 mm (0.14...0.28 in.) Wire: 0.25 mm² Operating temperature: –40...+85 °C (–40...+185 °F) Ingress protection: IP67 (correctly fitted) Fastening torque: 0.5 Nm</p>	<ul style="list-style-type: none"> • Connect wirelessly via Wi-Fi enabled device or via USB with the diagnostic tool • Simple connectivity to the sensor via 24 VDC power line (permissible cable length: 30 m) • User friendly interface for mobile devices and desktop computers • See product brief “TempoLink smart assistant” (document part no.: 551976) for further information 	<p>Material: PUR jacket; gray Features: Shielded Cable Ø: 8 mm (0.3 in.) Operating temperature: –40...+90 °C (–40...+194 °F)</p>

Cables			
			
<p>PUR cable Part no. 530 125</p>	<p>PVC cable Part no. 530 108</p>	<p>Cable with M12 D-coded male connector (4 pin), straight – M12 D-coded, male connector (4 pin), straight Part no. 530 064</p>	<p>Cable with M12 D-coded male connector (4 pin), straight – RJ45 male connector, straight Part no. 530 065</p>
<p>Material: PUR jacket; green Features: Cat 5, highly flexible Cable Ø: 6.5 mm (0.26 in.) Cross section: 2 × 2 × 0.35 mm² (22/7 AWG) Operating temperature: –20...+60 °C (–4...+140 °F)</p>	<p>Material: PVC jacket; gray Features: Shielded, flexible Cable Ø: 4.9 mm (0.19 in.) Cross section: 3 × 0.34 mm² Operating temperature: –30...+80 °C (–22...+176 °F)</p>	<p>Material: PUR jacket; green Features: Cat 5e Cable length: 5 m (16.4 ft) Cable Ø: 6.5 mm (0.26 in.) Ingress protection: IP65, IP67, IP68 (correctly fitted) Operating temperature: –30...+70 °C (–22...+158 °F)</p>	<p>Material: PUR jacket; green Features: Cat 5e Cable length: 5 m (16.4 ft) Cable Ø: 6.5 mm (0.26 in.) Ingress protection M12 connector: IP67 (correctly fitted) Ingress protection RJ45 connector: IP20 (correctly fitted) Operating temperature: –30...+70 °C (–22...+158 °F)</p>

* / Follow the manufacturer’s mounting instructions

Controlling design dimensions are in millimeters and measurements in () are in inches

ORDER CODE

1	2	3	4	5	6	7	8	9	10	11	12	13	14	15	16	17	18	19	20
R	P	5										D	5	6	1	U	3		1
a			b	c	d					e		f			g	h			

a	Sensor model
R	P 5 Profile

b	Design
G	Magnet slider backlash free (part no. 253 421), suitable for internal linearization
L	Block magnet L (part no. 403 448)
M	U-magnet OD33 (part no. 251 416-2), suitable for internal linearization
N	Magnet slider longer ball-jointed arm (part no. 252 183), suitable for internal linearization
O	No position magnet
S	Magnet slider joint at top (part no. 252 182), suitable for internal linearization
V	Magnet slider joint at front (part no. 252 184), suitable for internal linearization

c	Mechanical options
A	Standard
V	Fluorelastomer seals for the sensor electronics housing

d	Stroke length
X X X X M	0025...6350 mm
Standard stroke length (mm)	Ordering steps
25... 500 mm	25 mm
500...2500 mm	50 mm
2500...5000 mm	100 mm
5000...6350 mm	250 mm
X X X X U	001.0...250.0 in.
Standard stroke length (in.)	Ordering steps
1... 20 in.	1.0 in.
20...100 in.	2.0 in.
100...200 in.	4.0 in.
200...250 in.	10.0 in.
Non-standard stroke lengths are available; must be encoded in 5 mm / 0.1 in. increments	

e	Number of magnets
X X	01...30 position(s) (1...30 magnet(s))

f	Connection type
D 5 6	2 × M12 female connectors (5 pin), 1 × M8 male connector (4 pin)

g	System
1	Standard

h	Output
U 3 0 1	POWERLINK, position and velocity (1...30 position(s))
U 3 1 1	POWERLINK, position and velocity, internal linearization (1...30 position(s))

NOTICE

- For the RP5, the magnet selected in **b** "Design" is included in the scope of delivery. For multi-position measurements with more than 1 magnet, order the other magnets separately.
- The number of magnets is limited by the stroke length. The minimum allowed distance between magnets (i.e. front face of one to the front face of the next one) is 75 mm (3 in.).
- Use magnets of the same type for multi-position measurement, e.g. 2 × U-magnet (part no. 251 416-2).
- If the option for internal linearization (U311) in **h** "Output" is chosen, select a suitable magnet.

DELIVERY



- Sensor
 - Position magnet (not valid for RP5 with design »O«)
 - 2 mounting clamps up to 1250 mm (50 in.) stroke length
+ 1 mounting clamp for each 500 mm (20 in.) additional stroke length
- Accessories have to be ordered separately.

Manuals, Software & 3D Models available at:
www.mtssensors.com

UNITED STATES 3001 Sheldon Drive
MTS Systems Corporation Cary, N.C. 27513
Sensors Division Phone: +1 919 677-0100
Americas & APAC Region E-mail: info.us@mtssensors.com

GERMANY Auf dem Schüffel 9
MTS Sensor Technologie 58513 Lüdenscheid
GmbH & Co. KG Phone: +49 2351 9587-0
EMEA Region & India E-mail: info.de@mtssensors.com

ITALY Phone: +39 030 988 3819
Branch Office E-mail: info.it@mtssensors.com

FRANCE Phone: +33 1 58 4390-28
Branch Office E-mail: info.fr@mtssensors.com

UK Phone: +44 79 44 15 03 00
Branch Office E-mail: info.uk@mtssensors.com

SCANDINAVIA Phone: + 46 70 29 91 281
Branch Office E-mail: info.sca@mtssensors.com

CHINA Phone: +86 21 2415 1000 / 2415 1001
Branch Office E-mail: info.cn@mtssensors.com

JAPAN Phone: +81 3 6416 1063
Branch Office E-mail: info.jp@mtssensors.com

Document Part Number:
552009 Revision A (EN) 11/2019



ETHERNET
POWERLINK
certified product

www.mtssensors.com