

# Tempsonics®

Magnetostrictive Linear Position Sensors

## R-Series V RP Profinet RT & IRT Data Sheet

- Profinet with IRT (Isochronous Real Time)
- Position + velocity measurements for up to 30 magnets
- Field adjustments and diagnostics using the new TempoLink smart assistant

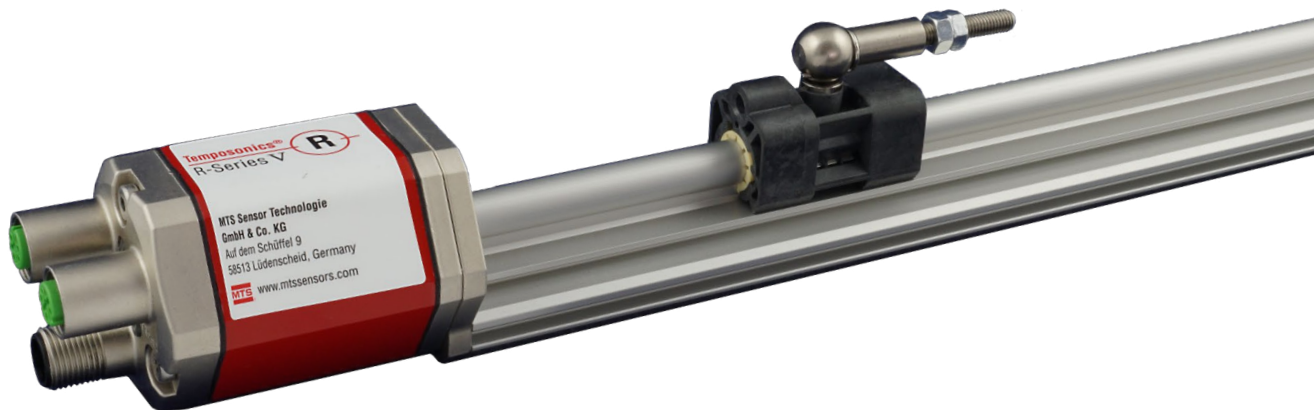

I AM THE NEW GENERATION

## MEASURING TECHNOLOGY

The absolute, linear position sensors provided by MTS Sensors rely on the company's proprietary Temposonics® magnetostrictive technology, which can determine position with a high level of precision and robustness. Each Temposonics® position sensor consists of a ferromagnetic waveguide, a position magnet, a strain pulse converter and supporting electronics. The magnet, connected to the object in motion in the application, generates a magnetic field at its location on the waveguide. A short current pulse is applied to the waveguide. This creates a momentary radial magnetic field and torsional strain on the waveguide. The momentary interaction of the magnetic fields releases a torsional strain pulse that propagates the length of the waveguide. When the ultrasonic wave reaches the end of the waveguide it is converted into an electrical signal. Since the speed of the ultrasonic wave in the waveguide is precisely known, the time required to receive the return signal can be converted into a linear position measurement with both high accuracy and repeatability.

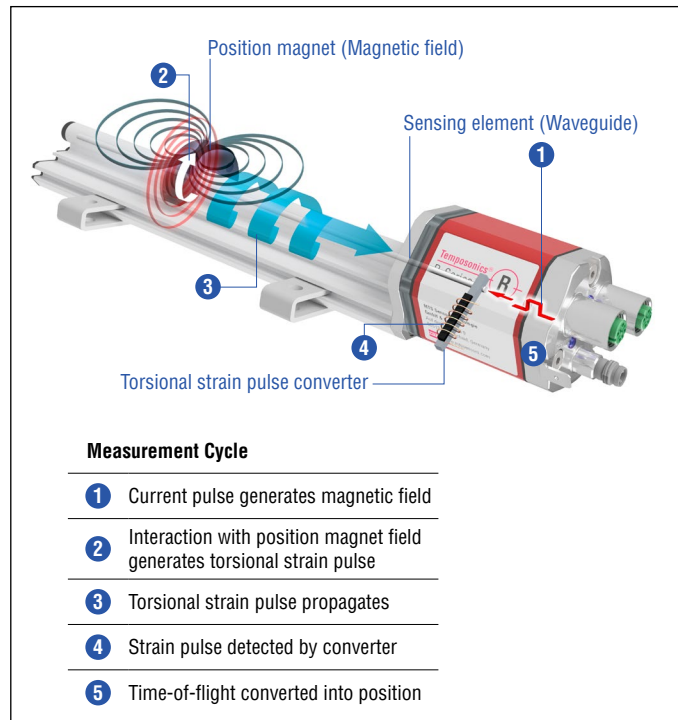

Fig. 1: Time-of-flight based magnetostrictive position sensing principle

## R-SERIES V PROFINET RT & IRT

Temposonics® R-Series V brings very powerful sensor performance to meet the many demands of your application. This series is the long term solution for harsh environments having high levels of shock and vibration. The sensors are available with Profinet RT (Real Time) and IRT (Isochronous Real Time). Profinet IRT offers a synchronized communication with a minimum cycle time as fast as 250 µs. For time-critical applications R-Series V with linear extrapolation enables synchronized controller communication for any stroke length of the sensor. In addition, the sensors are available with internal linearization which offers improved linearity for overall higher accuracy of the position measurement values.

With many outstanding features the R-Series V model sensors are fit for a very broad range of applications.

## TempoLink YOUR SMART ASSISTANT

The TempoLink smart assistant is an accessory for the R-Series V family of sensors that supports setup and diagnostics. Depending on the sensor protocol it enables the adjustment of parameters like measurement direction, resolution and filter settings. For diagnostics and analysis of operational data the R-Series V sensors continuously track values such as total distance traveled by the position magnet, internal temperature of the sensor and the quality of the position signal. This additional information can be read out via TempoLink smart assistant even while the sensor remains operational in the application.

The TempoLink smart assistant is connected to the sensor via the power connection, which now adds bidirectional communication for setup and diagnostics. The TempoLink smart assistant is operated using a graphical user-interface that will be displayed on your smartphone, tablet, laptop or PC. Just connect your Wi-Fi-enabled device to TempoLink Wi-Fi access point and go to the website URL for the user-interface.

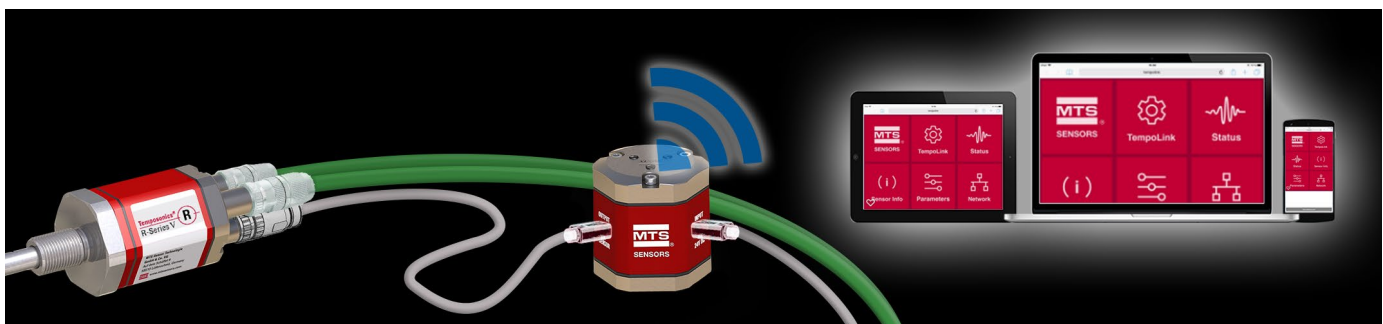

Fig. 2: R-Series V sensor with TempoLink Smart Assistant

## TECHNICAL DATA

Output						
Interface	Profinet RT Profinet IRT version 2.3					
Data protocol	MTS Profile and Encoder Profile 4.1					
Data transmission rate	100 MBit/s (maximum)					
Measured value	Position, velocity / option: Simultaneous multi-position and multi-velocity measurements up to 30 magnets					
Measurement parameters						
Resolution: Position	0.5...100 µm (selectable)					
Cycle time <sup>1</sup>	Stroke length	≤ 50 mm	≤ 715 mm	≤ 2000 mm	≤ 4675 mm	≤ 6350 mm
	Cycle time	250 µs	500 µs	1000 µs	2000 µs	4000 µs
Linearity deviation <sup>2</sup>	Stroke length	≤ 500 mm	> 500 mm			
	Linearity deviation	≤ ±50 µm	< 0.01 % F.S.			
Repeatability	< ±0.001 % F.S. (minimum ±2.5 µm) typical					
Hysteresis	< 4 µm typical					
Temperature coefficient	< 15 ppm / K typical					
Operating conditions						
Operating temperature	-40...+85 °C (-40...+185 °F)					
Humidity	90 % relative humidity, no condensation					
Ingress protection	IP65 (connectors correctly fitted)					
Shock test	150 g / 11 ms, IEC standard 60068-2-27					
Vibration test	30 g / 10...2000 Hz, IEC standard 60068-2-6 (excluding resonant frequencies)					
EMC test	Electromagnetic emission according to EN 61000-6-3					
	Electromagnetic immunity according to EN 61000-6-2					
	The sensor meets the requirements of the EC directives and is marked with <b>CE</b>					
Magnet movement velocity	Magnet slider: Max. 10 m/s; U-magnet: Any; block magnet: Any					
Design / Material						
Sensor electronics housing	Aluminum (painted), zinc die cast					
Sensor profile	Aluminum					
Stroke length	25...6350 mm (1...250 in.)					
Mechanical mounting						
Mounting position	Any					
Mounting instruction	Please consult the technical drawings on <a href="#">page 4</a> and the operation manual (document number: <a href="#">551973</a> )					
Electrical connection						
Connection type	2 × M12 female connectors (5 pin), 1 × M12 male connector (4 pin)					
Operating voltage	12...30 VDC ±20 % (9.6...36 VDC) <sup>3</sup>					
Power consumption	Less than 4 W typical					
Dielectric strength	500 VDC (DC ground to machine ground)					
Polarity protection	Up to -36 VDC					
Overvoltage protection	Up to 36 VDC					

1/ Sensor with standard settings. Further information can be found in the [operating manual R-Series V Profinet \(document number: 551973\)](#)

2/ With position magnet # 252 182

3/ Power supply must be able to provide current of 1 A for power up process

## TECHNICAL DRAWING

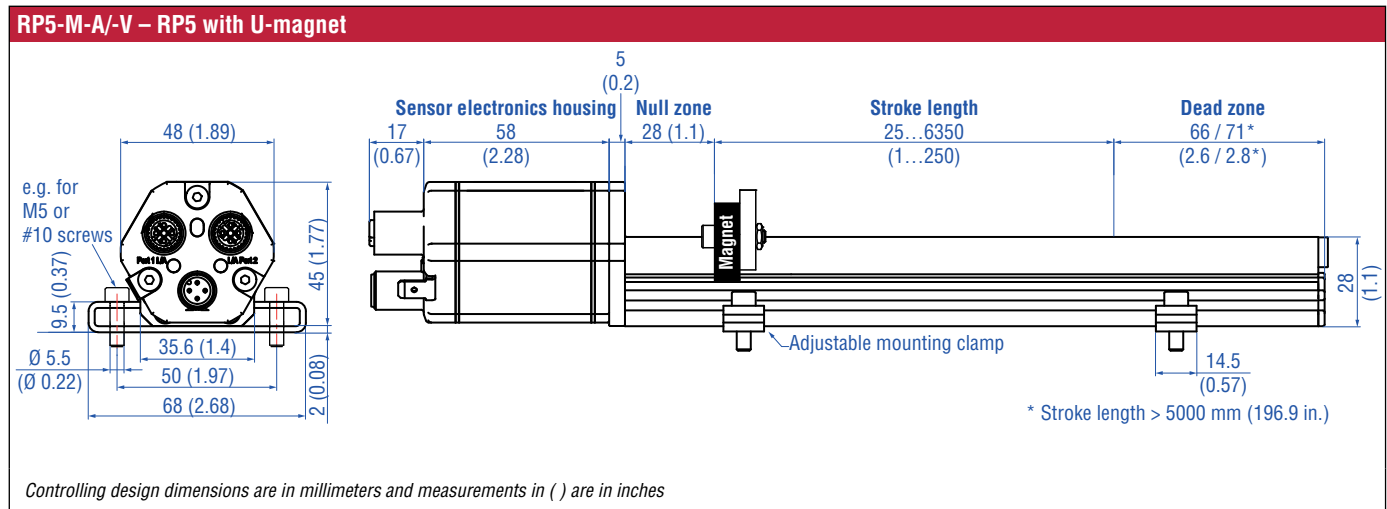



Fig. 3: Temposonics® RP5 with U-magnet

## CONNECTOR WIRING

D58		
<b>Signal</b>		
<b>Port 1 – M12 female connector (D-coded)</b>	<b>Pin</b>	<b>Function</b>
<p>View on sensor</p>	1	Tx (+)
	2	Rx (+)
	3	Tx (-)
	4	Rx (-)
	5	Not connected
<b>Port 2 – M12 female connector (D-coded)</b>	<b>Pin</b>	<b>Function</b>
<p>View on sensor</p>	1	Tx (+)
	2	Rx (+)
	3	Tx (-)
	4	Rx (-)
	5	Not connected
<b>Power supply</b>		
<b>M12 male connector (A-coded)</b>	<b>Pin</b>	<b>Function</b>
<p>View on sensor</p>	1	12...30 VDC ( $\pm 20\%$ )
	2	Not connected
	3	DC Ground (0 V)
	4	Not connected

Fig. 4: Connector wiring D58

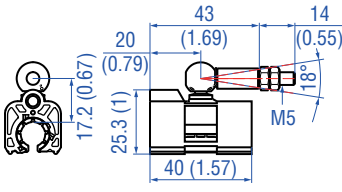
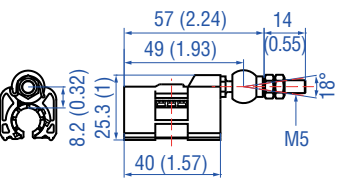
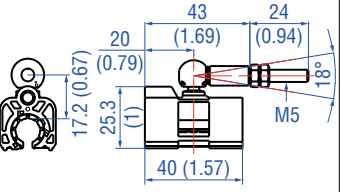
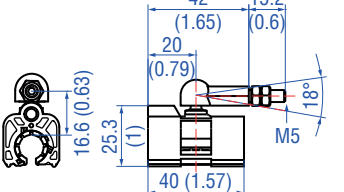

**FREQUENTLY ORDERED ACCESSORIES** – Additional options available in our [Accessories Guide](#)  [551444](#)

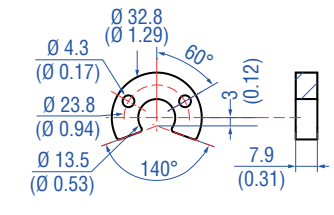
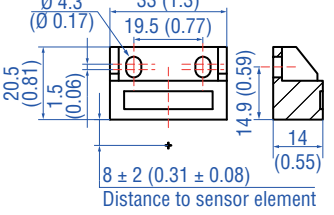
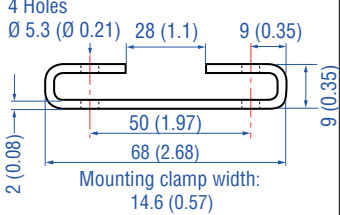
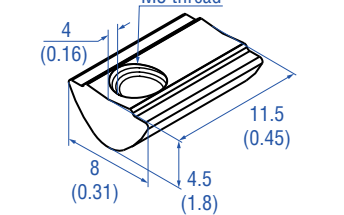
Position magnets			
			
<p><b>Magnet slider S, joint at top</b> Part no. 252 182</p>	<p><b>Magnet slider V, joint at front</b> Part no. 252 184</p>	<p><b>Magnet slider N</b> longer ball-joint arm Part no. 252 183</p>	<p><b>Magnet slider G, backlash free</b> Part no. 253 421</p>
<p>Material: GRP, magnet hard ferrite Weight: Approx. 35 g Operating temperature: -40...+75 °C (-40...+167 °F)</p>	<p>Material: GRP, magnet hard ferrite Weight: Approx. 35 g Operating temperature: -40...+75 °C (-40...+167 °F)</p>	<p>Material: GRP, magnet hard ferrite Weight: Approx. 35 g Operating temperature: -40...+75 °C (-40...+167 °F)</p>	<p>Material: GRP, magnet hard ferrite Weight: Approx. 25 g Operating temperature: -40...+75 °C (-40...+167 °F)</p>



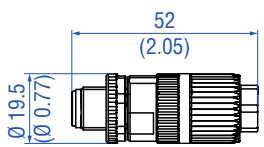
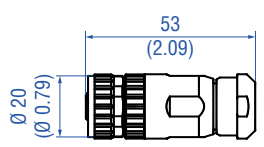
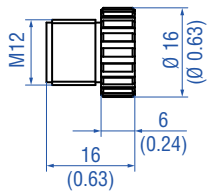

Position magnets	Mounting accessories		
			
<p><b>U-magnet OD33</b> Part no. 251 416-2</p>	<p><b>Block magnet L</b> Part no. 403 448</p>	<p><b>Mounting clamp</b> Part no. 400 802</p>	<p><b>T-nut</b> Part no. 401 602</p>
<p>Material: PA ferrite GF20 Weight: Approx. 11 g Surface pressure: Max. 40 N/mm<sup>2</sup> Fastening torque for M4 screws: 1 Nm Operating temperature: -40...+105 °C (-40...+221 °F)</p>	<p>Material: Hard ferrite Weight: Approx. 20 g Fastening torque for M4 screws: 1 Nm Operating temperature: -40...+75 °C (-40...+167 °F)</p> <p>This magnet may influence the sensor performance specifications for some applications.</p>	<p>Material: Stainless steel (AISI 304)</p>	<p>Fastening torque for M5 screw: 4.5 Nm</p>

Controlling design dimensions are in millimeters and measurements in ( ) are in inches

**Cable connectors<sup>4</sup>** **Programming tool**

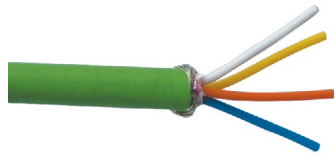
			
<p><b>M12 D-coded male connector (4 pin), straight</b> Part no. 370 523</p> <p>Material: Zinc nickel-plated Termination: Insulation-displacement Cable Ø: 5.5...7.2 mm (0.2...0.28 in.) Wire: 24 AWG – 22 AWG Operating temperature: -25...+85 °C (-13...+185 °F) Ingress protection: IP65/IP67 (correctly fitted) Fastening torque: 0.6 Nm</p>	<p><b>M12 A-coded female connector (5 pin), straight</b> Part no. 370 677</p> <p>Material: GD-Zn, Ni Termination: Screw Contact insert: CuZn Cable Ø: 4...8 mm (0.16...0.31 in.) Wire: 1.5 mm<sup>2</sup> Operating temperature: -30...+85 °C (-22...+185 °F) Ingress protection: IP67 (correctly fitted) Fastening torque: 0.6 Nm</p>	<p><b>M12 connector end cap</b> Part no. 370 537</p> <p>Female connectors M12 should be covered by this protective cap Material: Brass nickel-plated Ingress protection: IP67 (correctly fitted) Fastening torque: 0.39...0.49 Nm</p>	<p><b>TempoLink kit for Tempsonics® R-Series V</b> Part no. TL-1-0-EM12 (for D58)</p> <ul style="list-style-type: none"> <li>• Connect wirelessly via Wi-Fi enabled device or via USB with the diagnostic tool</li> <li>• Simple connectivity to the sensor via 24 VDC power line</li> <li>• User friendly interface for mobile devices and desktop computers</li> <li>• See product brief “TempoLink smart assistant” (document part no.: 551976) for further information</li> </ul>

**Cables**

			
<p><b>PUR cable</b> Part no. 530 125</p> <p>Material: PUR jacket; green Features: Cat 5, highly flexible Cable Ø: 6.5 mm (0.26 in.) Cross section: 2 × 2 × 0.35 mm<sup>2</sup> (22/7 AWG) Operating temperature: -20...+60 °C (-4...+140 °F)</p>	<p><b>PVC cable</b> Part no. 530 108</p> <p>Material: PVC jacket; gray Features: Shielded, flexible Cable Ø: 4.9 mm (0.19 in.) Cross section: 3 × 0.34 mm<sup>2</sup> Operating temperature: -30...+80 °C (-22...+176 °F)</p>	<p><b>Cable with M12 D-coded male connector (4 pin), straight – M12 D-coded, male connector (4 pin), straight</b> Part no. 530 064</p> <p>Material: PUR jacket; green Features: Cat 5e Cable length: 5 m (16.4 ft) Cable Ø: 6.5 mm (0.26 in.) Ingress protection: IP65, IP67, IP68 (correctly fitted) Operating temperature: -30...+70 °C (-22...+158 °F)</p>	<p><b>Cable with M12 D-coded male connector (4 pin), straight – RJ45 male connector, straight</b> Part no. 530 065</p> <p>Material: PUR jacket; green Features: Cat 5e Cable length: 5 m (16.4 ft) Cable Ø: 6.5 mm (0.26 in.) Ingress protection M12 connector: IP67 (correctly fitted) Ingress protection RJ45 connector: IP20 (correctly fitted) Operating temperature: -30...+70 °C (-22...+158 °F)</p>

Controlling design dimensions are in millimeters and measurements in ( ) are in inches

4/ Follow the manufacturer's mounting instructions

## ORDER CODE

1	2	3	4	5	6	7	8	9	10	11	12	13	14	15	16	17	18	19	20
R	P	5										D	5	8	1	U	4		
a			b	c	d					e		f			g	h			

a	Sensor model
R P 5	Profile

b	Design
G	Magnet slider, backlash free (part no. 253 421)
L	Block magnet L (part no. 403 448)
M	U-magnet, OD33 (part no. 251 416-2)
N	Magnet slider, longer ball-jointed arm (part no. 252 183)
O	No position magnet
S	Magnet slider, joint at top (part no. 252 182)
V	Magnet slider, joint at front (part no. 252 184)

c	Mechanical options
A	Standard
V	Fluorelastomer seals for the electronics housing

d	Stroke length
X X X X M	0025...6350 mm
Standard stroke length (mm)*	Ordering steps
25 ... 500 mm	25 mm
500...2500 mm	50 mm
2500...5000 mm	100 mm
5000...6350 mm	250 mm
X X X X U	001.0...250.0 in.
Standard stroke length (in.)*	Ordering steps
1 ... 20 in.	1 in.
20...100 in.	2 in.
100...200 in.	4 in.
200...250 in.	10 in.

e	Number of magnets
X X	01...30 Position(s) (1...30 magnet(s))

f	Connection type
D 5 8	2 × M12 female connectors (5 pin), 1 × M12 male connector (4 pin)

g	System
1	Standard

h	Output
U 4 0 1	Profinet RT & IRT with encoder profile (single position)
U 4 0 2	Profinet RT & IRT with MTS profile (single- & multi-position)
U 4 1 1	Profinet RT & IRT with encoder profile (single position) and internal linearization
U 4 1 2	Profinet RT & IRT with MTS profile (single- & multi-position) and internal linearization

### NOTICE

- For multi-position measurement the MTS profile for protocol options is required.
- Please specify magnet numbers for your sensing application and order separately.
- The number of magnets is limited by the stroke length. The minimum allowed distance between magnets (i.e. front face of one to the front face of the next one) is 75 mm (3 in.).
- Use magnets of the same type for multi-position measurement, e.g. 2 × U-magnets (part no. 251 416-2).

### DELIVERY



- Sensor
  - Position magnet (not valid for RP5 with design "O")
  - 2 mounting clamps up to 1250 mm (50 in.) stroke length  
+ 1 mounting clamp for each 500 mm (20 in.) additional stroke length
- Accessories have to be ordered separately.

\*/ Non standard stroke lengths are available; must be encoded in 5 mm / 0.1 in. increments

Manuals, Software & 3D Models available at:  
[www.mtssensors.com](http://www.mtssensors.com)

**UNITED STATES** 3001 Sheldon Drive  
MTS Systems Corporation Cary, N.C. 27513  
Sensors Division Phone: +1 919 677-0100  
E-mail: info.us@mtssensors.com

---

**GERMANY** Auf dem Schüffel 9  
MTS Sensor Technologie 58513 Lüdenscheid  
GmbH & Co. KG Phone: +49 2351 9587-0  
E-mail: info.de@mtssensors.com

---

**ITALY** Phone: +39 030 988 3819  
Branch Office E-mail: info.it@mtssensors.com

---

**FRANCE** Phone: +33 1 58 4390-28  
Branch Office E-mail: info.fr@mtssensors.com

---

**GREAT BRITAIN** Phone: +44 79 44 15 03 00  
Branch Office E-mail: info.uk@mtssensors.com

---

**CHINA** Phone: +86 21 6485 5800  
Branch Office E-mail: info.cn@mtssensors.com

---

**JAPAN** Phone: +81 3 6416 1063  
Branch Office E-mail: info.jp@mtssensors.com

---

**Document Part Number:**  
551961 Revision A (EN) 05/2018



[www.mtssensors.com](http://www.mtssensors.com)